



Our kids are our passion.™

# Freedom Designs, Inc. Simply Seating Order Form



### Customer Information

Date: \_\_\_\_\_  
 Purchase Order #: \_\_\_\_\_  
 Dealer / Acct. #: \_\_\_\_\_  
 Ship to Street: \_\_\_\_\_  
 Ship to City: \_\_\_\_\_  
 Ship to State: \_\_\_\_\_  
 Ship to Zip Code: \_\_\_\_\_  
 Office / Mobile #: \_\_\_\_\_  
 Office Fax #: \_\_\_\_\_  
 E-mail Address: \_\_\_\_\_  
 Quote to:  E-mail  Fax  
 Buyer: \_\_\_\_\_  
 Marked For: \_\_\_\_\_

### Seating Specifications

A Back Height: \_\_\_\_\_  
 B Lateral Height: \_\_\_\_\_  
 C Lateral Width: \_\_\_\_\_  
 D Hip Width (rear): \_\_\_\_\_  
 E Set Up Seat Depth: \_\_\_\_\_  
 F Hip Width (front): \_\_\_\_\_  
 G "E" + 3" for Growth: \_\_\_\_\_  
 H Seat Width: \_\_\_\_\_  
 I Back Width: \_\_\_\_\_

### Finished Dimensions

Standard cut is Boltaron with foam rolled over

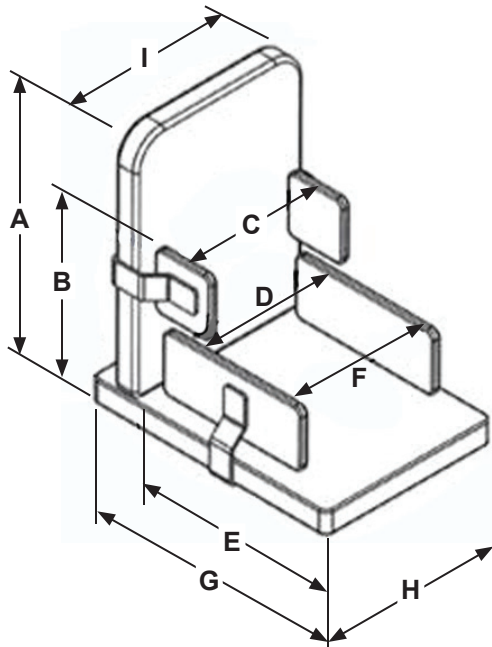

### Wheelchair Specifications

Model: \_\_\_\_\_  
 Width: \_\_\_\_\_  
 Depth: \_\_\_\_\_

### Freedom Designs Upholstery Selections

1. Choose Contact / Non-Contact
2. Choose Upholstery
3. Choose Component

	Seat Base	Back Base	Headrest Pad	Lateral Pads	Hip & Knee Pads
<b>Body Contact Surface</b>					
<b>Bravo "Silver" Anti-Microbial Upholstery</b>					
Choose Standard in Black Only	<input type="checkbox"/>	<input type="checkbox"/>	<input type="checkbox"/>	<input type="checkbox"/>	<input type="checkbox"/>
Choose Reversed in Black Only	<input type="checkbox"/>	<input type="checkbox"/>	<input type="checkbox"/>	<input type="checkbox"/>	<input type="checkbox"/>
<b>Cushioned AirMesh Breathable Upholstery</b>					
Choose Standard	<input type="checkbox"/>	<input type="checkbox"/>	<input type="checkbox"/>	<input type="checkbox"/>	<input type="checkbox"/>
Choose Incontinence Resistance Liner	<input type="checkbox"/>	<input type="checkbox"/>	<input type="checkbox"/>	<input type="checkbox"/>	<input type="checkbox"/>
<b>"Other" Upholstery Options</b>					
Number: _____ Choose	<input type="checkbox"/>	<input type="checkbox"/>	<input type="checkbox"/>	<input type="checkbox"/>	<input type="checkbox"/>
<b>Body Non-Contact Surface</b>					
Choose Standard in Black Only	<input type="checkbox"/>	<input type="checkbox"/>	<input type="checkbox"/>	<input type="checkbox"/>	<input type="checkbox"/>
Choose Reversed in Black Only	<input type="checkbox"/>	<input type="checkbox"/>	<input type="checkbox"/>	<input type="checkbox"/>	<input type="checkbox"/>
<b>Cushioned AirMesh Breathable Upholstery</b>					
Choose Standard	<input type="checkbox"/>	<input type="checkbox"/>	<input type="checkbox"/>	<input type="checkbox"/>	<input type="checkbox"/>
Choose Incontinence Resistance Liner	<input type="checkbox"/>	<input type="checkbox"/>	<input type="checkbox"/>	<input type="checkbox"/>	<input type="checkbox"/>
<b>"Other" Upholstery Options</b>					
Number: _____ Choose	<input type="checkbox"/>	<input type="checkbox"/>	<input type="checkbox"/>	<input type="checkbox"/>	<input type="checkbox"/>
<b>Monogram Option</b>	<input type="checkbox"/>	<b>When ordering choose either Monogram or Embroidery</b>			
Name: _____					
<i>Script</i> <input type="checkbox"/>					
Block <input type="checkbox"/>					
Thread Color: _____					
<b>Embroidery Option</b>	<input type="checkbox"/>				
Design: _____					

**Note:** Freedom's **NEW** "BRAVO SILVER" fabric is another important step we have taken to help keep our kids healthy. An "ANTIBACTERIAL" fabric, "BRAVO SILVER" utilizes "SILVER TECHNOLOGY" to create a barrier to help control bacterial growth on contact. "BRAVO SILVER" is also latex free, highly incontinence resistant, fire retardant and FDA approved. Similar to Dartex, "BRAVO SILVER" has a standard surface or can be reversed for easy cleaning.

Freedom's Cushioned AirMesh fabric is designed to be used primarily on back support surfaces. Bonded to AirMesh fabric is a thin layer of reticulated foam. As the body moves the foam expands and contracts under pressure from movement. Air is circulated through the AirMesh upholstery to ventilate the back to help cool the body.

### Freedom Install Program

Purchase Order #: \_\_\_\_\_ for Frame for Install  
**Freedom Install Program does not include power wheelchairs.**



Our kids are our passion.™

# Freedom Designs, Inc.

## Simply Seating Order Form

### Seat

Marked for \_\_\_\_\_

#### Step 1. EB1-Kit (Seat)

**\$980.00**

#### Simply Seating EB Seat Kit includes:

- Boltaron planar / flat base 1/2" thick up to 18" x 18" size • cut full width • 2" x 2" back post notches • Boltaron "T" nutted for tracks, hinge and medial thigh support • base sizes larger than 18" x 18" require a quote • tracks for hardware and accessory attachment
- base attachment hardware • seat back hinge • up to 18" x 18" x 1 1/2" 4 lb. foam • 3 sided zipper enclosed cover

#### Choose Hardware Option

**Note:** Hinged seat hardware choice must match hinged back hardware choice (A - A, B - B, etc).

- A** EB1 - Kit - Two Point Attachment & Seat to Back Hinge (crash test approved) (E2607)

- 2 - 585A Fast Clamps Attachment Hardware
- 2 - 582A Short L Brackets
- 2 - SEZFC EZ Frame Clamps
- 2 - 436 Aluminum 30 Degree Clamps
- 1 - Seat to Back Hinge (pair) - Choose One

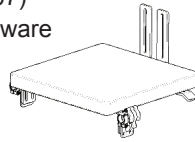

**Note:** Choose 1 Hinge from **D** options

- A1** EB1 - EXT - Kit - Two Point Attachment & Seat to Back Hinge (crash test approved) (E2607)

- 2 - 504B EZLITE EXTENDED Snap Attachment Hardware
- 2 - SEZFC EZ Frame Clamps
- 2 - 436 Aluminum 30 Degree Clamps
- 1 - Seat to Back Hinge (pair) - Choose One

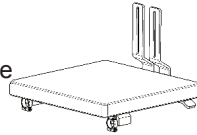

**Note:** Choose 1 Hinge from **D** options

- B** EB1 - 4 - Kit - Four Point Attachment with **NO** Seat to Back Hinge (crash test approved) (E2607)

- 4 - 585A Fast Clamps Attachment Hardware
- 4 - 582 Short L Brackets
- 2 - SEZFC EZ Frame Clamps

- C** EB1CSKHRDWR - Kit - Two Point Attachment & Seat to Back Hinge (crash test approved)

- 2 - Knob Hardware
  - 2 - 436 Aluminum 30 Degree Clamps
- Note:** Choose 1 Hinge from **D** options

- D** Seat to Back Hinge Options

- 1 - 430A (pair) Seat to Back Hinge Flush
- 1 - 430 (pair) Seat to Back Hinge Offset

#### Step 2. Choose Customization to EB1 Seat

- EB1CS1K** Anti-Thrust Add \$187

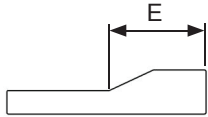

- Height of anti-thrust shelf is 1"
- E = First 1/3 of seat set up depth (see page 1)

- EB1CS1Y** Contour Add \$320

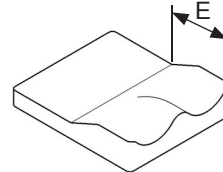

- Leg trough depth is 1"
- Height of anti-thrust is 1"
- E = First 1/3 of seat set up depth (see page 1)

- EB1CS1CR** Asymmetrical - Long Rt. Add \$ 78

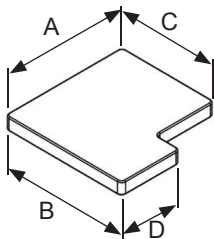

- A \_\_\_\_\_
- B \_\_\_\_\_
- C \_\_\_\_\_
- D \_\_\_\_\_

- EB1CS1CL** Asymmetrical - Long Lt. Add \$ 78

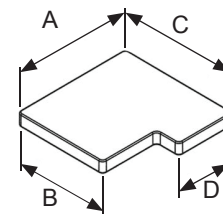

- A \_\_\_\_\_
- B \_\_\_\_\_
- C \_\_\_\_\_
- D \_\_\_\_\_

- EB1CS1MLB** 1/2" Maple Laminate Base n/c

- EB1CS1WT** Base with T Nuts for Hardware n/c  
No tracks included

- EB1CS1EE** Base Only Between Rails Add \$161

- EB1CS1G** Cushion Separate from Base Add \$ 94

- EB1CS1DD** Modular Contour Add \$424

- EB1CS1UU** Cut, Carve, Contour Add \$411

- EB1CS1L** Grid Cut Add \$296

- EB1CS1I** Incontinence Resistance Liner Add \$ 26

- EB1CS1FF** Incontinence Slip Cover Add \$200

Foam	Part Number	Bottom Thickness	Top Thickness
Sunmate - Soft \$73 per 1"	EB1CSSUN1		
Sunmate - Medium \$73 per 1"	EB1CSSUN1		
T Foam - Soft \$79 per 1"	EB1CSTFOAM1		
T Foam - Medium \$79 per 1"	EB1CSTFOAM1		
Pudgee \$205 per 1"	EB1CSPUDG1		
4 lb Foam \$40 per 1"	EB1CSHIGHD1		
3 lb Foam \$40 per 1"	EB1CSSTAN1		
5 lb Foam \$42 per 1"	EB1CSTUF1		



# Freedom Designs, Inc.

## Simply Seating Order Form

### Back

Marked for \_\_\_\_\_

**Step 1. EB2-Kit (Back)**

**\$1030.00**

**Simply Seating EB2 Back Kit includes:**

Boltaron planar / flat base 1/2" thick up to 18" x 18" size • cut between rails unless otherwise specified • Boltaron "T" nutted for tracks, hinge and headrest plate • base sizes larger than 18" x 18" require a quote • tracks for hardware and accessory attachment • base attachment hardware • headrest adapt-a-plate • anterior trunk support strap risers • 3 sided zipper enclosed cover

Choose Hardware Option

**Note:** Hinged back hardware choice must match hinged seat hardware choice (A - A, B - B, etc).

- A**  EB2 - Kit - Two point Attachment & Seat to Back Hinge (crash test approved) (E2617)

- 2 - 583A Easy Clamps Attachment Hardware
- 2 - 582B Long L Brackets
- 2 - SEZFC EZ Frame Clamps

**Note:** Choose 1 strap riser pair from **D**

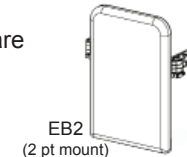

- C**  EB2CBKHRDWR - Kit - Two Point Attachment & Seat to Back Hinge (crash test approved) (E2617)

- 2 - Knob Hardware

**Note:** Choose 1 strap riser pair from **D**

- B**  EB2 - 4 - Kit - Four Point Attachment with **NO** Seat to Back Hinge (crash test approved) (E2617)

- 4 - 585A Fast Clamps Attachment Hardware
- 4 - 582B Long L Brackets
- 2 - SEZFC EZ Frame Clamps

**Note:** Choose 1 strap riser pair from **D**

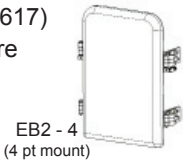

- D**  Strap Riser Choices (choose 1 pair)

- 2 - Mod-6A 1 1/2" Wide Strap Opening Flat
- 2 - Mod-6A 1" Wide Strap Opening Flat
- 2 - Mod-6B 1 1/2" Wide Strap Opening 25° Back Bend
- 2 - Mod-6B 1" Wide Strap Opening 25° Back Bend

**Step 2. Choose Customization to EB2 Back**

- EB2CB2I Curved Base Add **\$119**
- EB2CB2IA Curved Foam Add **\$103**

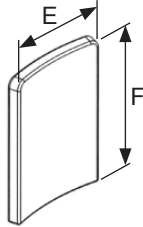

E \_\_\_\_\_  
F \_\_\_\_\_

- EB2CB2H "I" Base Add **\$114**
- EB2CB2J "T" Base Add **\$114**

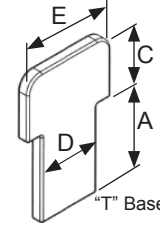
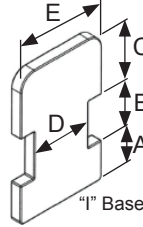

A \_\_\_\_\_  
B \_\_\_\_\_  
C \_\_\_\_\_  
D \_\_\_\_\_  
E \_\_\_\_\_

- EB2CB2L Biangular Cut / Dual Covers Add **\$270**
- EB2CB2LA Biangular Cut / Single Cover Add **\$270**

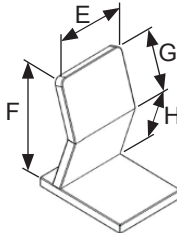

E \_\_\_\_\_  
F \_\_\_\_\_  
G \_\_\_\_\_  
H \_\_\_\_\_

- EB2CB2DD Adjustable Lumbar Add **\$266**

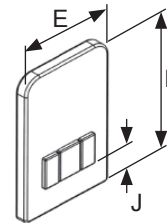

E \_\_\_\_\_  
F \_\_\_\_\_  
J \_\_\_\_\_

- EB2CB2MLB 1/2" Maple Laminate Base n/c
- EB2CB2WT Base with T Nuts for Hardware n/c
- EB2CB2GG Ergo Adjustable Add **\$376**
- EB2CB2K Grid Cut (when combined with EB2CB2DD, grid is above lumbar only) Add **\$296**

- EB2CB2S Free Form Base Soft Box Add **\$231**
- EB2CB2SM Free Form Base Med Box Add **\$231**
- EB2CB2SBAG Free Form Base Soft Bag Add **\$231**
- EB2CB2S1 Liquid Sunmate Box Kit Soft Add **\$215**
- EB2CB2S1M Liquid Sunmate Box Kit Med Add **\$215**
- EB2CB2S1BAG Liquid Sunmate Bag Kit Soft Add **\$231**

Foam	Part Number	Bottom Thickness	Top Thickness
Sunmate - Soft	\$94 per 1" EB2CBSUN2		
Sunmate - Medium	\$94 per 1" EB2CBSUN2		
T Foam - Soft	\$101 per 1" EB2CBTFOAM2		
T Foam - Medium	\$101 per 1" EB2CBTFOAM2		
Pudgee	\$222 per 1" EB2CBPUDG2		
4 lb Foam	\$40 per 1" EB2CBHIGHD2		
3 lb Foam	\$40 per 1" EB2CBSTAN2		
5 lb Foam	\$55 per 1" EB2CBTUF2		



# Freedom Designs, Inc.

## Simply Seating Order Form

### Accessories

Marked for \_\_\_\_\_

#### Medial Thigh Support (Abductor)

- EE3B-2 Lever Flip Down \$414  
(push lever down) (E0957/E1028)
- EE3S Push Button Flip Down \$394  
(push button in) (E0957/E1028)
- EE3P Hide Away - Lever Flip Down \$414  
(pull lever up) (E0957/E1028)

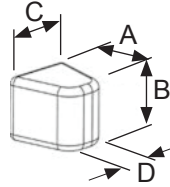

- |         |                                  |                     |
|---------|----------------------------------|---------------------|
| A _____ | Standard                         |                     |
| B _____ | <input type="checkbox"/> Small   | 3L x 4H x 3-2 Taper |
| C _____ | <input type="checkbox"/> Medium  | 4L x 3H x 3-2 Taper |
| D _____ | <input type="checkbox"/> Large   | 5L x 4H x 4-2 Taper |
|         | <input type="checkbox"/> X-Large | 5L x 5H x 5-3 Taper |

#### Hip Guides

- EE4A (hip) Straight Pad (no contour) (E0956) \$221/pair
- EE4B (hip) Offset Pad (no contour) (E0956) \$221/pair
- EE4A (knee) Straight Pad (no contour) \$221/pair
- EE4B (knee) Offset Pad (no contour) \$221/pair
- EE4C Quick Release (E0956/E1028) \$443/pair
- Mod-4A Add Contour for Anti-Thrust \$ 84/pair

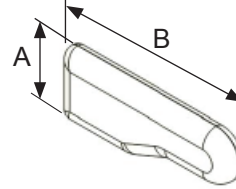

A = 4" high or \_\_\_\_\_"  
 B = Set up seat depth or \_\_\_\_\_"

#### Trunk Supports

- EE5A Straight Non-Swing Away \$221/pair (E0956)
- EE5B Offset Non-Swing Away \$221/pair (E0956)
- EE5E Lift Swing Away \$443/pair (E0956/E1028)
- EE5W **NEW** Push Button Swing Away \$443/pair (E0956/E1028)
- EE5P Lever Swing Away \$497/pair (E0956/E1028)
- EE5K Lift Swing Away Summer Winter \$591/pair (E0956/E1028)
- EE5Q Lever Swing Away Summer Winter \$625/pair (E0956/E1028)
- Mod-5F Protective Covering Over Hardware \$ 50/pair

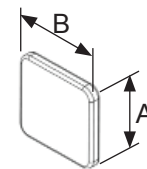

- |                                  |
|----------------------------------|
| A _____                          |
| B _____                          |
| <input type="checkbox"/> 4L x 3H |
| <input type="checkbox"/> 5L x 4H |
| <input type="checkbox"/> 6L x 5H |

- |  |  |
|--|--|
| Trunk Supports                           |  |
| <input type="checkbox"/> Std. (1" thick) | or <input type="checkbox"/> Thin (.5" thick) |
| <input type="checkbox"/> Flat            | or <input type="checkbox"/> Curved           |

#### Headrest Pads (E0955)

- |  |  |  |   |       |
|--|--|--|---|-------|
| <input type="checkbox"/> 7756 Chubbie        | <input type="checkbox"/> Small 10W x 4H    | <input type="checkbox"/> Medium 12W x 5H   | <input type="checkbox"/> Large 13.5W x 4.5H | \$184 |
| <input type="checkbox"/> 7757 Low Profile    | <input type="checkbox"/> Small 8.5W x 3.5H | <input type="checkbox"/> Medium 9W x 4H    | <input type="checkbox"/> Large 13W x 4H     | \$133 |
| <input type="checkbox"/> 7753 3-Piece Hinged | <input type="checkbox"/> Small 4W x 4H     | <input type="checkbox"/> Medium 5W x 4H    | <input type="checkbox"/> Large 5W x 5H      | \$280 |
| <input type="checkbox"/> 7760 Skinny         | <input type="checkbox"/> Small 8W x 4.5H   | <input type="checkbox"/> Medium 10W x 4.5H | <input type="checkbox"/> Large 12W x 4.5H   | \$184 |

#### Headrest Hardware (E1028)

- 7700 Vertical and horizontal adjustment, removable \$128
- 7711 **NEW** AdjustEze Multi-position removable \$225
- 7702 Flip Down non-removable \$276
- 7708 Rock and Roll Removable \$385
- 7709 Rock and Roll Flip Down \$394

#### Ankle Supports

- |   |                                  |                                |                                 |                                |       |
|---|----------------------------------|--------------------------------|---------------------------------|--------------------------------|-------|
| <input type="checkbox"/> EE9B-D High Top, Buckle, Dynamic | <input type="checkbox"/> X-Small | <input type="checkbox"/> Small | <input type="checkbox"/> Medium | <input type="checkbox"/> Large | \$109 |
| <input type="checkbox"/> EE9F-D 3 Point High Tops         | <input type="checkbox"/> X-Small | <input type="checkbox"/> Small | <input type="checkbox"/> Medium | <input type="checkbox"/> Large | \$166 |
| <input type="checkbox"/> EE9H Ankle and Foot Positioners  | <input type="checkbox"/> X-Small | <input type="checkbox"/> Small | <input type="checkbox"/> Medium | <input type="checkbox"/> Large | \$206 |
| Ankle Circumference Range                                 | (5 1/2 - 8 1/2")                 | (7 1/2 - 10 1/2")              | (9 1/2 - 12 1/2")               | (11 1/2 - 14 1/2")             |       |

#### Shoe Holders

- |   |                            |                             |                            |                             |                            |                             |       |
|---|----------------------------|-----------------------------|----------------------------|-----------------------------|----------------------------|-----------------------------|-------|
| <input type="checkbox"/> EE9 Shoe Holders - Velcro  | <input type="checkbox"/> S | <input type="checkbox"/> SM | <input type="checkbox"/> M | <input type="checkbox"/> ML | <input type="checkbox"/> L | <input type="checkbox"/> XL | \$163 |
| <input type="checkbox"/> EE9C Shoe Holders - Buckle | <input type="checkbox"/> S | <input type="checkbox"/> SM | <input type="checkbox"/> M | <input type="checkbox"/> ML | <input type="checkbox"/> L | <input type="checkbox"/> XL | \$163 |
| <input type="checkbox"/> EE9G Shoe Holders - Combo  | <input type="checkbox"/> S | <input type="checkbox"/> SM | <input type="checkbox"/> M | <input type="checkbox"/> ML | <input type="checkbox"/> L | <input type="checkbox"/> XL | \$163 |
| Shoe Holder Length                                  | (5")                       | (5 3/4")                    | (6 1/2")                   | (7 1/4")                    | (8")                       | (10")                       |       |

#### Belts

- |  |                             |                            |                            |                            |                             |       |
|--|-----------------------------|----------------------------|----------------------------|----------------------------|-----------------------------|-------|
| <input type="checkbox"/> SB-3334 EZ-Release, 2 pt., Center Pull        | <input type="checkbox"/> XS | <input type="checkbox"/> S | <input type="checkbox"/> M | <input type="checkbox"/> L | <input type="checkbox"/> XL | \$ 88 |
| <input type="checkbox"/> SB-3362 EZ-Release, 4 pt., Center Pull        | <input type="checkbox"/> XS | <input type="checkbox"/> S | <input type="checkbox"/> M | <input type="checkbox"/> L | <input type="checkbox"/> XL | \$108 |
| <input type="checkbox"/> SB-3331 Squeeze Release, 2 pt., Center Pull   | <input type="checkbox"/> XS | <input type="checkbox"/> S | <input type="checkbox"/> M | <input type="checkbox"/> L | <input type="checkbox"/> XL | \$ 67 |
| <input type="checkbox"/> SB-3332 Metal Push Button, 2 pt., Center Pull | <input type="checkbox"/> XS | <input type="checkbox"/> S | <input type="checkbox"/> M | <input type="checkbox"/> L | <input type="checkbox"/> XL | \$ 88 |



# Freedom Designs, Inc.

## Simply Seating Order Form

### Trays and Footboxes

Marked for \_\_\_\_\_

#### Trays

- |                          |  |       |
|--------------------------|--|-------|
| <input type="checkbox"/> | 08-17000 EZ-Lite 1/4" Lexan Tray No Hardware (E0950)   | \$ 93 |
|                          | <input type="checkbox"/> MOD-8N Set of 3 Ribs (K0108)  | \$ 47 |
|                          | <input type="checkbox"/> Wood  | n/c   |
|                          | <input type="checkbox"/> Lexan   | n/c   |
|                          | <input type="checkbox"/> Aluminum  | n/c   |
|                          | <input type="checkbox"/> 559 Adjustable Channel Bracket (ea.) Left Side (E1028)                                      | \$ 65 |
|                          | <input type="checkbox"/> 559 Adjustable Channel Bracket (ea.) Right Side (E1028)                                     | \$ 65 |
| <input type="checkbox"/> | 08-12000 EZ-Lite Tray 1/4" Lexan Tray with Adjustable Channel Bracket Hardware (E0950/E1028)                         | \$167 |
| <input type="checkbox"/> | 08-13000 EZ-Lite Tray 1/4" Lexan Tray with Ribs and Adjustable Channel Bracket Hardware (E0950/E1028)                | \$179 |
| <input type="checkbox"/> | 08-8000 3/8" Lexan Tray No Hardware (E0950/E1028)  | \$156 |
|                          | <input type="checkbox"/> MOD-8N Set of 3 Ribs (K0108)  | \$ 47 |
|                          | <input type="checkbox"/> Wood  | n/c   |
|                          | <input type="checkbox"/> Lexan   | n/c   |
|                          | <input type="checkbox"/> Aluminum  | n/c   |
|                          | <input type="checkbox"/> 454A Knob Release Hardware (ea.) Left Side (E1028)  | \$ 50 |
|                          | <input type="checkbox"/> 454A Knob Release Hardware (ea.) Right Side (E1028)   | \$ 50 |
|                          | <input type="checkbox"/> 461 Channel Bracket Hardware (ea.) Left Side (K0108)  | \$ 65 |
|                          | <input type="checkbox"/> 461 Channel Bracket Hardware (ea.) Right Side (K0108)                                       | \$ 65 |
| <input type="checkbox"/> | 08-6000 3/8" Lexan Tray with Ribs and Adjustable Knob Release Hardware (E0950/E1028)                                 | \$215 |
| <input type="checkbox"/> | 08-2000 3/8" Lexan Tray with Ribs and Channel Bracket Hardware (E0950/E1028)   | \$266 |
|                          | <input type="checkbox"/> MOD-8J Rear Stability Belt (K0108) (recommended for any tray with channel bracket hardware) | \$ 38 |

Tray Size	
Size	Description
<input type="checkbox"/> X-Small	10" - 11" wide chair, tray dimensions - 21" wide x 18" deep, body cut out - 10" wide x 7" deep
<input type="checkbox"/> Small	12" - 13" wide chair, tray dimensions - 21" wide x 18" deep, body cut out - 12" wide x 7" deep
<input type="checkbox"/> Medium	14" - 15" wide chair, tray dimensions - 24" wide x 22" deep, body cut out - 14" wide x 9" deep
<input type="checkbox"/> Large	16" - 17" wide chair, tray dimensions - 26" wide x 24" deep, body cut out - 16" wide x 10" deep
<input type="checkbox"/> X-Large	18" - 19" wide chair, tray dimensions - 28" wide x 24" deep, body cut out - 18" wide x 10" deep

#### Footbox

- |   |           |   |           |
|---|-----------|---|-----------|
| <input type="checkbox"/> 08-10000 Leg Cradles | \$537 pr. | <input type="checkbox"/> 08-11000 Footbox | \$459 ea. |
|---|-----------|---|-----------|

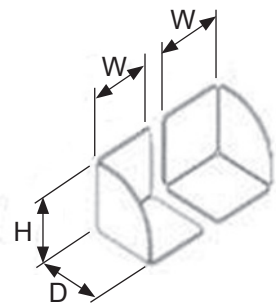

- Hanger Mount
- Footplate/Footboard Mount

W - Fits between hangers

D \_\_\_\_\_

H \_\_\_\_\_

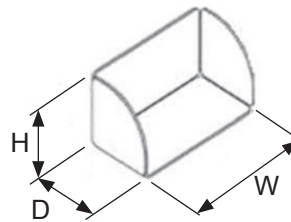

- Hanger Mount
- Footplate/Footboard Mount

W - Fits between hangers

D \_\_\_\_\_

H \_\_\_\_\_

Notes:



**Freedom Designs, Inc.**  
*Simply Seating Order Form*  
**Anterior Chest Supports** Marked for \_\_\_\_\_

(E0960)

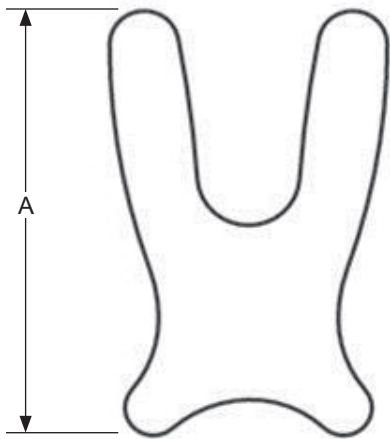

EE6R \$161

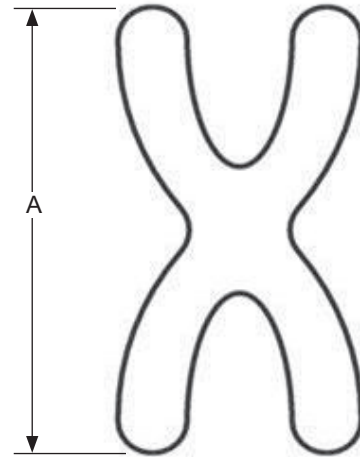

EE6S \$161

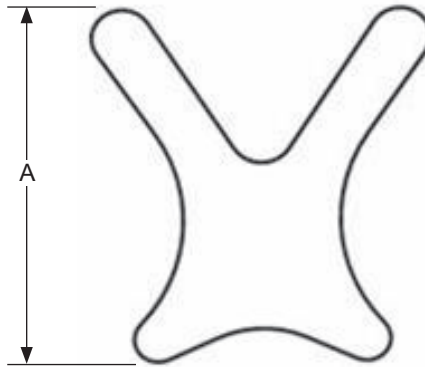

EE6U \$161

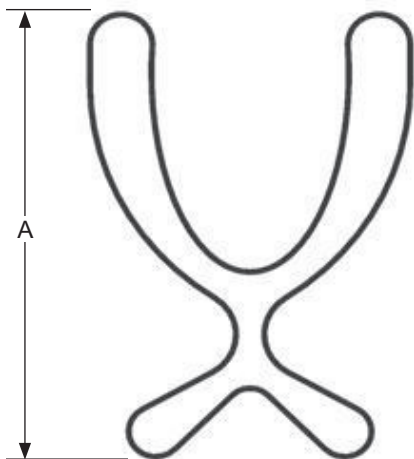

EE6V \$161

- Size

  - XXSmall
  - XSmall
  - Small
  - Medium
  - Large
  - XLarge

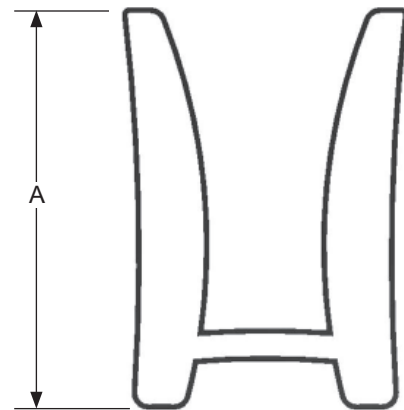

EE6X \$161

Height of Pad (A)						
Chest Support	XXS	XS	S	M	L	XL
EE6R	12"	15.5"	17.25"	18.75"	20.25"	21.5"
EE6S	12.5"	14.25"	15.5"	17"	18.25"	20"
EE6U	N/A	10"	11"	11.75"	12.5"	14.5"
EE6V	N/A	10"	14"	16.25"	20"	22"
EE6X	N/A	N/A	9.25"	11.25"	13.5"	N/A